

# KX·NX Driver



F A S T E N I N G I N N O V A T I O N  
f o r T H E F U T U R E



With cushion attachment



With vacuum attachment

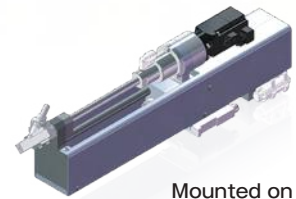

Mounted on single spindle unit



Mounted on arm driver

**Supports wide range applications from manual fastening to robot.**



Mounted on screw driving robot

# Function comparison table by series

\*\* : Optional

		KX Driver SD550 series	NX Driver SD550T series	NX Driver SD600T series
Specifications	Torque range	0.08~45N·m	0.2~80N·m	0.5~45N·m
	Torque accuracy	—	$3\sigma/\bar{x} = 3\%$ or less or $5\%$ or less	$3\sigma/\bar{x} = 2\%$ or less or $3\%$ or less
	Torque detection method	Current value detection	Torque sensor (strain gauge)	Torque sensor (strain gauge)
	Number of programs	16	16	32
Port	USB	1 port (Type-B)	1 port (Type-B)	1 port (Type mini-B)
	RS485	1 port	1 port	1 port
	Ethernet	—	—	1 port
	CAN	—	—	1 port
Fastening operation	Fastening method (Torque)	○	○	○
	Fastening method (Angle)	○	○	○
	Fastening method (Torque / Angle)	○	○	○
	Sync fastening operation	○	○	○
	Torque judgment	—	○	○
	Final fastening angle judgment	○	○	○
	Pulse type screw height judgement	○	○	○
Functions	Waveform analysis	○ **	○ **	○
	Data collection (CAN) ※1	—	—	○
	Data collection (Ethernet)	—	—	○
	Serial communication (tightening result output)	○	○	○
	Field network(EtherNet/IP™)	—	—	○ **
	Field network(EtherCAT®)	—	—	○ **
Communication software	Edit settings	○	○	○
	Memory sheet setting support	—	—	○
	Waveform display	[Time]-[Current value, Rotating speed] [Angle]-[Current value]	[Time]-[Torque, Rotating speed] [Angle]-[Torque]	[Time]-[Torque, Rotating speed, Rotating angle] [Angle]-[Torque]
	Number of displayable waveforms	3 ※2	3 ※2	20
	Check waveform variation range	○ ** ※3	○ ** ※3	○
	Fastening result monitor	—	—	○
	I/O monitor	—	—	○
	Edit waveform settings	○ ** ※3	○ ** ※3	○
	Data collection	—	—	○
Standard set contents	Tool unit 1pc	○	○	○
	Controller 1pc	○	○	○
	Motor cable ※4 1pc	○	○	○
	Encoder cable ※4 1pc	○	○	○
	Sensor cable ※4 1pc	—	○	○
	Power connector ※5 1pc	○	○	○
	I/O connector ※5 1pc	○	○	○
	Network connector (485) 1pc	○	○	○
	CAN communication connector 1pc	—	—	○

※1 SD500T α series (old model) compatible function ※2 [Time]-[Current value], [Time]-[Torque] waveform only ※3 Supported by waveform analysis software  
 ※4 Cable length: 2m, 3m\*\*, 5m, 7.5m, 10m\*\* ※5 Optional assembled cable available [Cable length: 2m, 3m, 4m, 7m, 10m]

## KX Driver SD550 series

### Most suitable fastening with fine driver control

Fastening torque, speed etc. can be set individually with original AC servo motor which achieves most suitable driver control for various work applications.

Not only miniature screw tightening which is hard for conventional electric driver, effective for resin materials and thin plates also.

Fastening torque to be setup by electric currency percentage.

### Features

- Torque, speed, time, angle, etc. can be set individually with numeric values.
- Fastening conditions can be selected for each point (16 types)
- Waveform analysis function is available as an option. Detects fastening fault that could not be detected by torque judgment alone.

 Maximum rotation speed 420~3,000min <sup>-1</sup>	 Torque range 0.08~45N·m
--	--



## NX Driver SD550T series



### Equipped with a torque sensor for further reliability improvement

Improves fastening reliability by mounting torque sensor onto proven KX driver.

Achieves high quality fastening required by safety critical components etc.

### Features

- Torque, speed, time, angle, etc. can be set individually with numeric values.
- Fastening conditions can be selected for each point (16 types)
- Can get fastening torque result and OK/NG judgement immediately after each tightening.
- Can output fastening results by serial communication.
- Waveform analysis function is available as an option. Detects fastening fault that could not be detected by torque judgment alone.

 Maximum rotation speed 220~1,200min <sup>-1</sup>	 Torque range 0.2~80N·m	 Torque accuracy 3~5%
--	---	---



## NX Driver SD600T series

### High-end model chasing for higher accuracy and advanced functions

In addition to improving basic fastening performance, SD600T series brings safe and reliable operation with functions of data collection and waveform analysis.

### Features



- Torque, speed, time, angle, etc. can be set individually with numeric values.
- Fastening conditions can be selected per point-by point. Supports wide range applications with small quantities. (32 types)
- Waveform analysis function is available as standard. Detects tightening abnormalities that could not be detected by torque judgment alone.
- Equipped with data acquisition function by Ethernet for traceability and fastening defect analysis.
- Meet CE marking requirements of EMC directive, Low voltage directive and RoHS directive. ※1
- Supports field networks (EtherNet/IP™, EtherCAT®). Introduction of IoT can be done more easily. ※2

 Maximum rotation speed 420~1,100min <sup>-1</sup>	 Torque range 0.5~45N·m	 Torque accuracy 2~3%
--	---	---



※1 NX200T3 and NX500T3 do not support CE marking. ※2 Optional



# 1 / Fastening method

## Various fastening mode to support various applications

Standard fastening modes are "Two-step fastening", "Selftapping screw fastening", "Bolt fastening", "Nut fastening", "Forward rotation", "Reverse rotation", "Sync. fastening" etc.  
 These modes do not require complicated program, just input some numeric values only.  
 In addition, non-standard operations according to customer's requirement are also available as "User program (optional)".

### 1/-1 Two-step fastening

#### What is Two-step fastening?

Standard fastening mode of KX and NX driver.  
 In case of single step fastening, actual fastening torque could exceed target torque because of impact torque arisen by impact when screw head seated.  
 With two-step fastening, impact torque can be controlled by two steps, "initial fastening" and "final fastening", which brings "fast and accurate performance".

#### Check initial rotation:

Rotate the driver with no load and check if there were any rotational resistance due to damage on the device.

#### Initial fastening:

Fastening with "high speed and low torque" from start to screw head seating to avoid impact torque.

#### Final fastening:

Fastening with "low speed and high torque" from screw head seating to the target torque to secure torque stability.

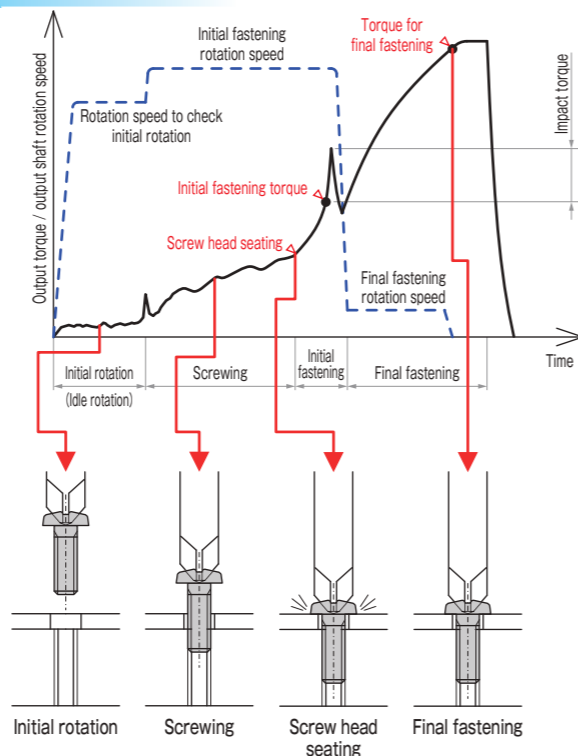

Two-step fastening waveform image

### 1/-2 Selftapping screw fastening

#### What is selftapping screw fastening?

Fastening mode to fasten selftapping screw into the thin plate with tap forming (female threads forming).  
 In case of "Two-step fastening" mode, when required thread forming torque is bigger than the target torque, as fastening torque would reach to the target torque while thread forming, operation would be stopped (finished) even if screw head is not seated yet.  
 Also, if the screw is fastened with the torque for threads forming, as fastening torque is bigger than the target torque, product (work) could be broken because of too much high torque.  
 To avoid such problems mentioned above, with tap forming process in addition to the two-step tapping, tightening can be performed with required torque no matter how high or low the tap forming torque is.

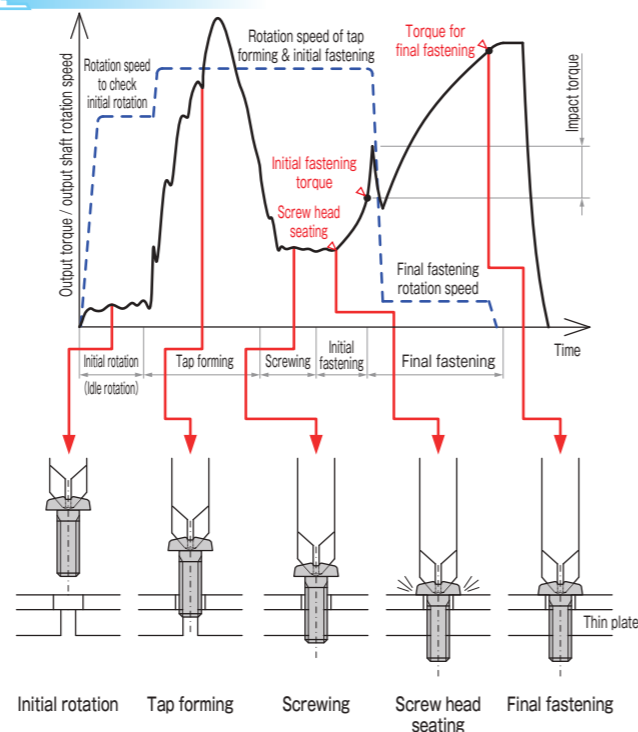

Sample waveform of selftapping screw fastening

# 2 / Data communication

## Display the fastening result on the touch panel / Save the tightening result to the PLC

Data can be output to external control device (PLC, etc.) using serial communication or field network.  
 The data captured by PLC can be also displayed on the touch panel or stored to certain storage like SD card with the program made by customer.

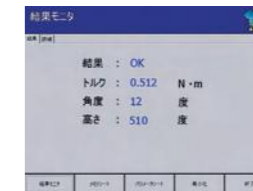

Touch panel screen image

### 2/-1 Serial communication

After fastening is completed, tightening result can be automatically sent to external control device (PLC, etc.) as serial data.

- Output data** : Torque value (NX) or current value (KX), final fastening angle, screw height check, fastening judgment result.
- Connection method** : One to one connection of serial port on the external control device (PLC, etc.) and RS485 connector on driver controller.



### 2/-2 Field network

Compatible with EtherNet/IP™ or EtherCAT®. ※1, ※2  
 Wiring saving and IoT can be achieved more easily. (Optional)

- Possible to be controlled by the driver signal without conventional external I/O cable.
- The cyclic communication enables programless data communication such as work information or fastening results.



#### Main communication data of EtherNet/IP™ or EtherCAT® (excerpt)

Data	Data descriptions
Driver control data	I/O control signal (16 bits each for input and output)
Fastening result data	Setting value, torque value, angle, fastening time, NG information, alarm number etc.
Real-time update data ※3	Torque data, rotation speed, rotation angle, elapsed time, etc.
Input data from external control device	Work information (up to 20 digits), work number, fastening point number, etc.

※1 EtherNet/IP™ is a trademark of ODVA.  
 ※2 EtherCAT® is a registered trademark and patented technology, licensed by Beckhoff Automation GmbH, Germany.  
 ※3 Data acquisition timing depends on capture timing of external control device.

# 3 / Data collection

## Most suitable for traceability! Save all fastening results and waveform data to PC

Fastening data can be collected with Ethernet connection using "SD600T communication software" installed in the PC. The software is effective to establish the traceability and to analyze the cause of screw fastening fault.

- Acquire fastening result data and waveform data, then display them on the screen or save them into the file in CSV format.
- The data saved can be selected by fastening result (OK only, NG only or all).
- The data saved can be read out in Excel file.
- Using EtherNet/IP™ or EtherCAT®, work information (product S/N) and point information can be received from PLC, which enables association of collected data and work information.

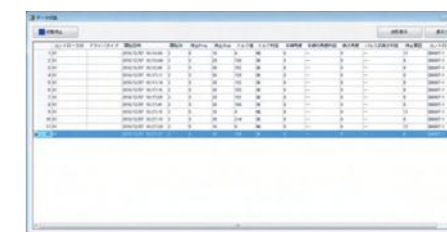

Tightening result view

- Collected data** : ● Fastening information (torque value, final fastening angle, height angle, fastening time, judgment result, start date and time, start CH)  
 ● Memory sheet setting value information  
 ● Work information (product S/N, points) ※1  
 ● Error information (process number, stop step, stop factor), etc.

**Connecting method** : Connect driver controller and personal computer with LAN cable.

**Connectable PC units** : Up to four units can be connected. For multiple connection, please use industrial network hub. ※2

※1 Only when using EtherNet/IP™ or EtherCAT®.  
 ※2 Up to eight units can be connected when collect fastening results only, without waveform data.

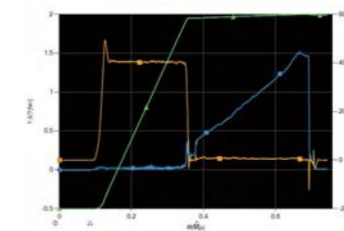

Fastening waveform view

# 4/ Communication software

Communication software for maintenance is prepared for each series

## 4/-1 Screwdriving parameters

KX(SD550)	NX(SD550T)	NX(SD600T)
●	●	●

**Edit fastening torque value settings, rotation speed etc.**

- Easy edit by setting chart view.
- Save the data in the file and back up.
- Color coding of necessary setting items in the chart.

### Memory sheet screen

[SD600T]



**Easy setting by the easy memory sheet setting screen (SD600 only)**

- Work out necessary setting values automatically only by target torque input.
- Display estimated fastening time by key in screw nominal size and length.

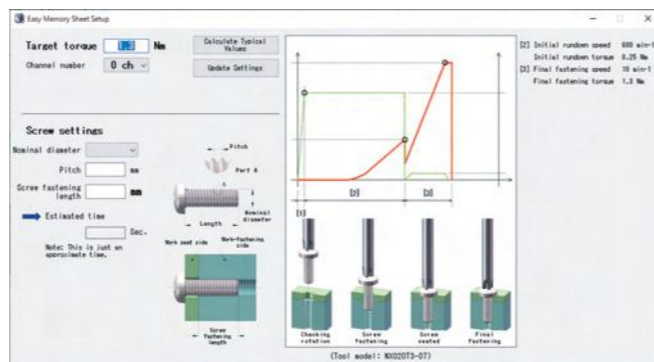

# 5/ Waveform analysis

KX(SD550)	NX(SD550T)	NX(SD600T)
● **	● **	●

\*\* : Optional

Judge fastening OK/NG with waveform analysis, finding out fastening abnormality which have ever be detected!

OK or NG of fastening can be judged by comparing real-time waveform and OK waveform set in the controller. This will detect fastening defects which could not be jaded by torque value judgment only.

### KX driver reference waveform (comparison between waveform and tightening operation)

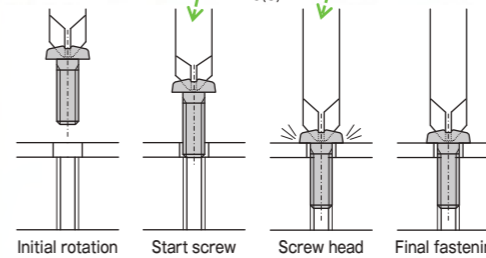
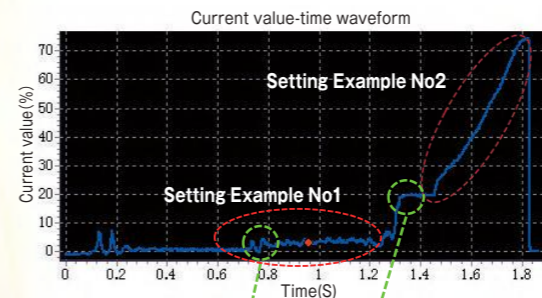

### Setting example No1 (OK range set by red waveform)

The abnormal fastening condition like cross thread can be detected at the first step of operation.

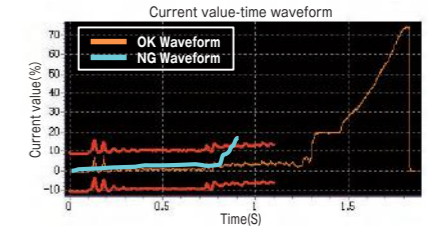

### Setting example No2 (OK range set by red waveform)

Final fastening detects differences of screw head seating conditions like with or without of spring washer etc.

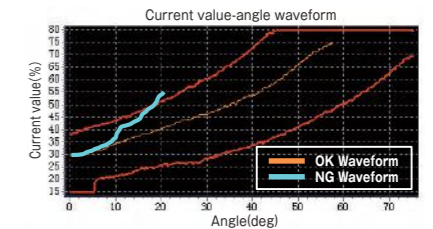

## 4/-2 Waveform display

Display the product fastening waveform and check the screw fastening condition

KX(SD550)	NX(SD550T)	NX(SD600T)
●	●	●

### Fastening waveform image

[SD600T] [Time]-[Torque, rotation speed, rotation angle] waveform

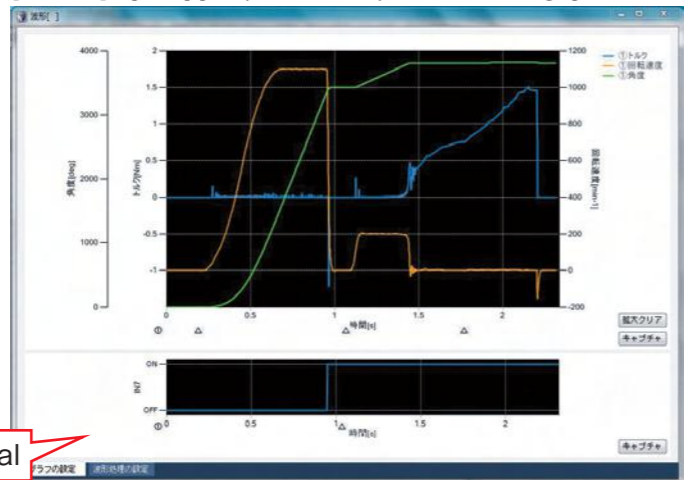

Input signal

※Display the input signal linked to the waveform

## 4/-3 Driver status monitor

Check the driver status with communication software

KX(SD550)	NX(SD550T)	NX(SD600T)
—	—	●

**I/O monitor** Can check I/O input-output status at a glance.

**Fastening results monitor** Can check fastening status like fastening torque, angle, time, fastening NG details etc.

**Operation monitor** The driver can be rotated from the software.

## Driver model range

Output shaft torque(N·m)	KX Driver SD550 series						NX Driver SD550T series						NX Driver SD600T series							
	M8	M8	M8	M8	M8	M8	M8	M8	M8	M8	M8	M8	M8	M8	M8	M8	M8	M8		
100																				
10																				
1	0.45	0.91	1.22	2.6	3.8	8.2														
0.1	0.08	0.16	0.24	0.5	0.8	1.6														
0.01																				
Output shaft	M8	M8	M8	M8	M8	M8	M8	M8	M8				M8	M8	M8					
Tool unit model#	050T2-01	100T2-01	150T2-01	100T2-03	150T2-03	150T2-07	08T2-03	020T2-07	050T2-07	100T2-07	180T2-05	250T2-07	500T2-0E	800T2-1B	020T3-07	050T3-07	100T3-07	200T3-06	500T3-0A	
Torque range(N·m)	0.08~0.45	0.16~0.91	0.24~1.22	0.5~2.6	0.8~3.8	1.6~8.2	0.2~0.8	0.5~2.0	1.0~5.0	2.5~9.0	5.0~18	8.0~24	15~45	30~80	0.5~2.0	1.0~5.0	2.5~9.0	5.0~20	10~45	
Recommended torque range(N·m)	0.15~0.30	0.3~0.6	0.6~1.0	1.0~2.0	2.0~3.2	3.2~7.0														
Max. speed (min <sup>-1</sup> )	3,000			1,800			1,200		840		1,100		840		420		220			
Torque accuracy	—						3σ/x̄=5% or less			3σ/x̄=3% or less			3σ/x̄=3% or less		3σ/x̄=2% or less					
Tool unit weight (kg)	0.45	0.55	0.65	0.66	0.76	0.87	2.1	2.9	0.6	1.0	1.1	1.2	2.0	2.4	2.6	1.1	1.2	1.3	3.2	3.7
Controller model#	SD550N05						SD550N10		SD550T03		SD550T05		SD550T10		SD600T03		SD600T05		SD600T10	
Power supply requirements	Single-phase AC200-230V ±10% 50/60Hz AC100~115V ** ※1						Single-phase AC200-230V ±10% 50/60Hz		Single-phase AC200-230V ±10% 50/60Hz				Single-phase AC200-230V ±10% 50/60Hz		Single-phase AC200-230V ±10% 50/60Hz					
Max. electrical load(kVA)	0.35	0.5	0.65	0.5	0.65	1.2	0.6	0.45	0.6	0.75	1.3		0.45		0.6	0.75	1.4			
Controller weight (kg)	0.75						0.95		0.75		0.95		1.4		1.5					

※1 When using an AC power supply unit (optional)

# Dimensions

## KX Driver SD550 series

KX050T2, KX100T2, KX150T2 Tool unit

Output shaft type  
Select: M, S or H  
Following models  
M or H only  
KX050T2-01  
KX100T2-01

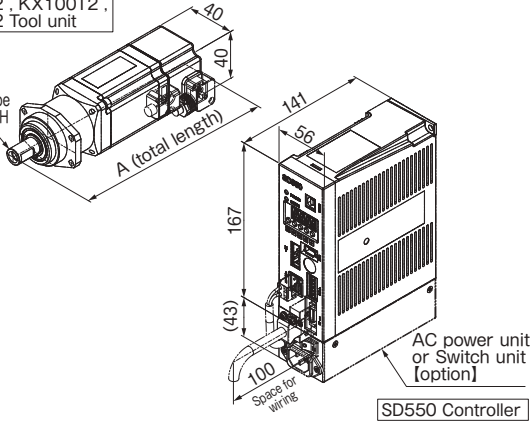

KX400T2 Tool unit

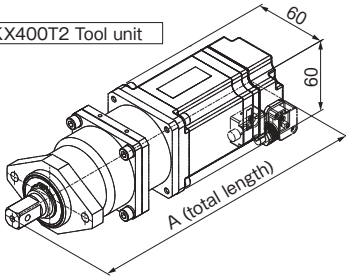

Model	A
KX050T2-01	133
KX100T2-01	145
KX150T2-01	157
KX100T2-03	145
KX150T2-03	157
KX150T2-07	188
KX400T2-07	224.1
KX400T2-14	251.2

## Output shaft dimensions

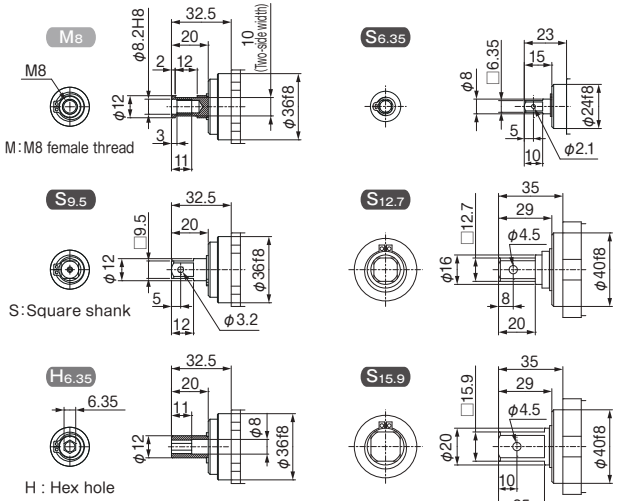

## Mounting dimensions

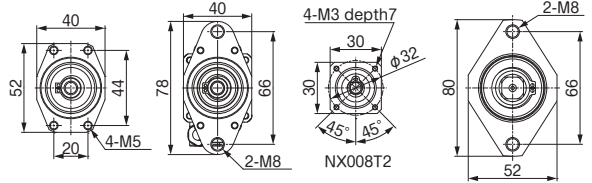

KX050~150T2 Old model (TU series)  
NX020~180T2 Compatible mounting flange  
NX020~100T3 For mounting 4-M5 (20 x 44 pitch)

※M10 female thread for NX800T2 only  
KX400T2, NX250T2 NX500T2, NX800T2 NX200T3, NX500T3

## NX Driver SD550T series

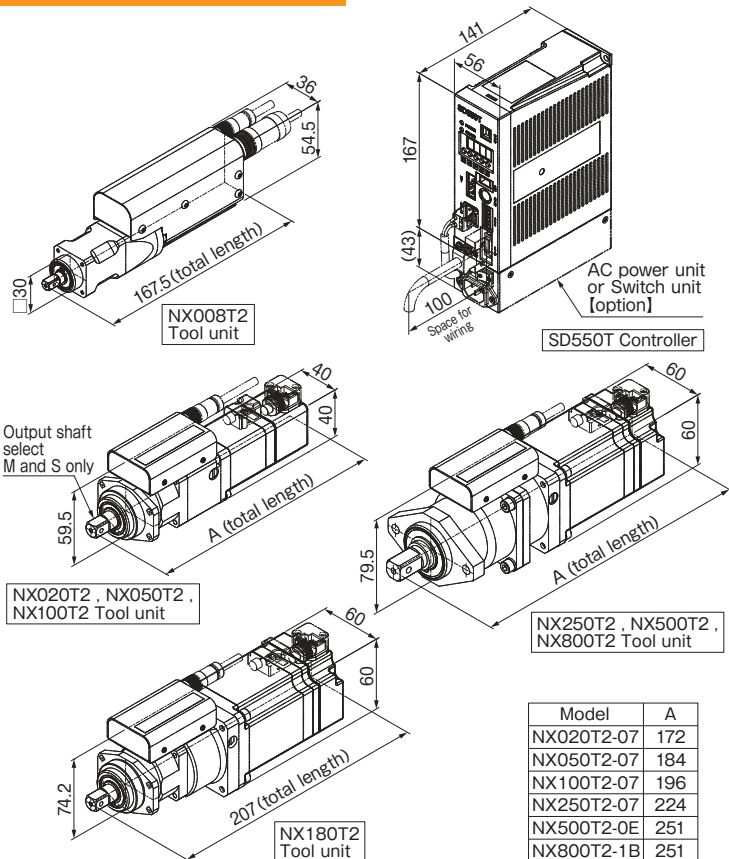

Model	A
NX020T2-07	172
NX050T2-07	184
NX100T2-07	196
NX250T2-07	224
NX500T2-0E	251
NX800T2-1B	251

※Outline dimensional drawing CAD data can be downloaded from the website.

## NX Driver SD600T series

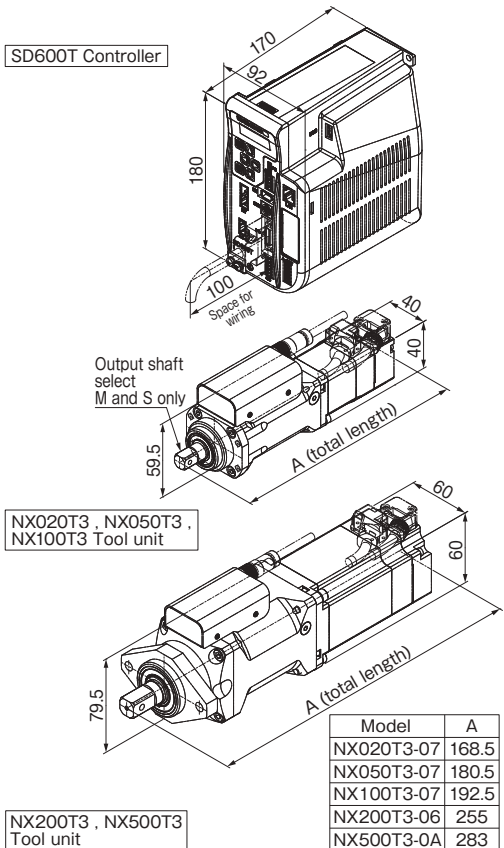

Model	A
NX020T3-07	168.5
NX050T3-07	180.5
NX100T3-07	192.5
NX200T3-06	255
NX500T3-0A	283

# NITTOSEIKO CO.,LTD.

Assembly Machine Division / Shiroyama Plant  
Global Sales section.

2, Shiroyama-chou, Ayabe-city, Kyoto 623-0003, Japan  
TEL: +81-773-42-1290 FAX: +81-773-45-3680  
URL: <https://www.nittoseiko.co.jp/en.html>

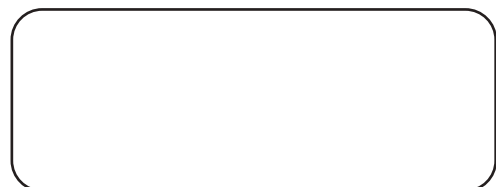

● Specifications and other matters are subject to modifications for performance improvements without notice.  
● Unique nouns like the product name indicated in this brochure are registered or not registered trademark of each company.